

# Quick User Guide

## Seaory S20 Desktop Single-side Card Printer



**Shenzhen Seaory Technology Co., Ltd.**

## 1. Unpacking and inspection

1) Open the top cover, you will see following items:

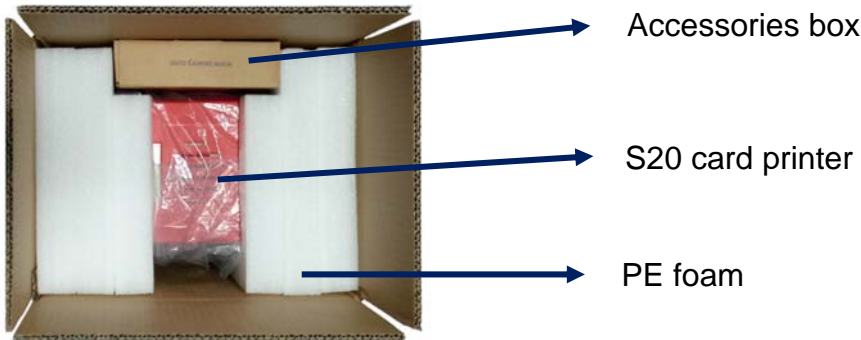

2) Accessories list:



1PC power adapter



1PC power cable



1PC USB cable



1PC ICARDE software CD

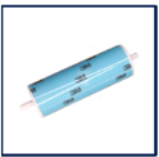

1PC cleaning roller



5pcs cleaning card



1PC warranty card



1PC cleaning stick

**i** If the above accessories are in short supply, please contact your local distributor immediately.

3) Appearance introduction:

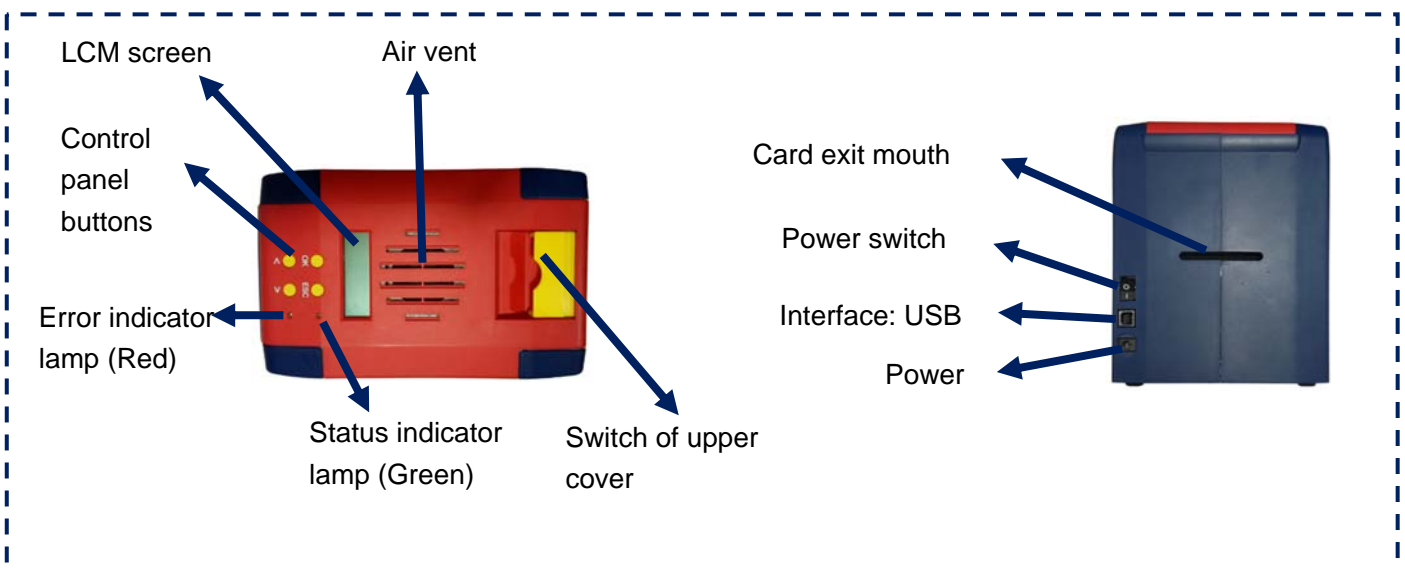

## 2. Cleaning Roller Installation

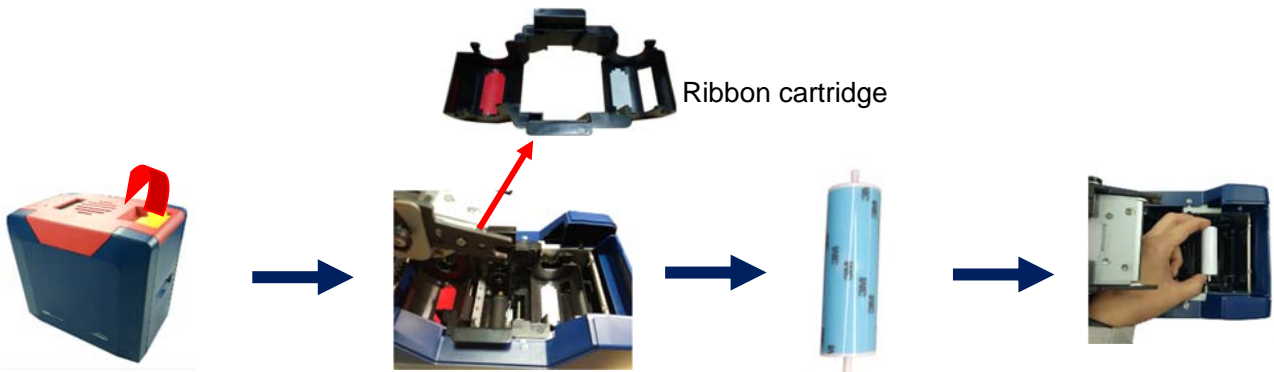

1. Gently lift the upper cover switch.

2. Open upper cover, take out the ribbon cartridge.

3. Remove 3M hyaline layer on cleaning roller surface.

4. Take the cleaning roller's both sides by hand. After pushing into the mounting position, gently press down.



The purpose of the cleaning wheel is to absorb the dust on the card and improve the printing effect. Replace cleaning roller after every roll of ribbon use up.

## 3. Ribbon Installation



1. Open the upper cover, take out the ribbon cartridge, install the ribbon into the cartridge according to the color direction.

2. Red roller supply with unused ribbon. White roller supply with used ribbon.

3. Take ribbon cartridge's side, Red roller close to the Back-end card exit mouth, install the ribbon cartridge.



In order to ensure the normal use of the printer, please use Seatory original ribbon.

## 4. Driver installation

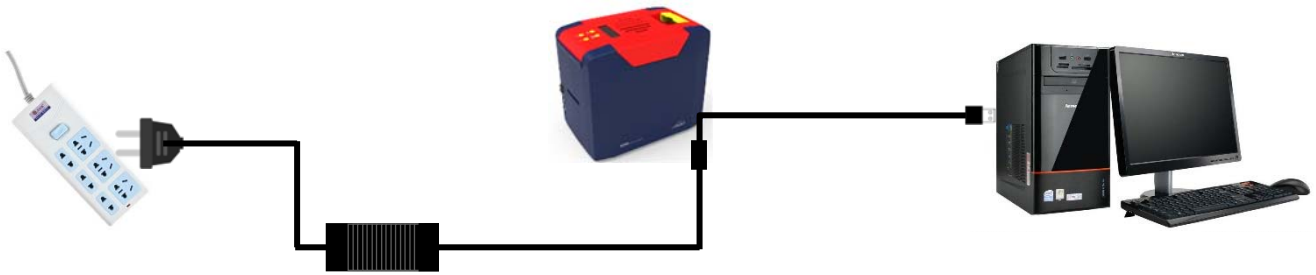

1. Power adapter 24V connector is inserted into card printer power interface. Connect the power cable to the power adapter. Then plug the power cable into the mains socket. But do not power on until the driver installation is complete.

2. Connect the square port of the USB cable to the card printer and connect the flat port to the USB port of the computer.

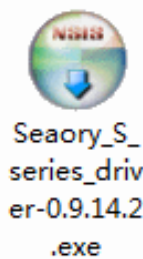

3. Use CD-rom or download the driver installation package on the Seatory's official website, double-click above driver installation package.

4. Click "Install".

**i** Please install driver by administrator and close all antivirus applications before installation.

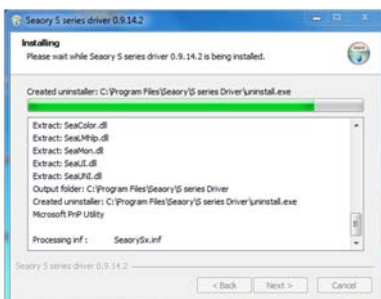

5. Begin to install, please wait for a while.



6. During the installation process, when the above page appears. Please select always trust software from "Shenzhen Seatory Technology CO., LTD" in the pop-up windows, then click the "Install" button.

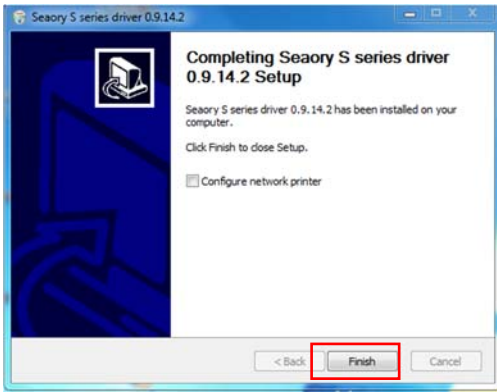

7. Wait for one minute, this page appears, click "finish".

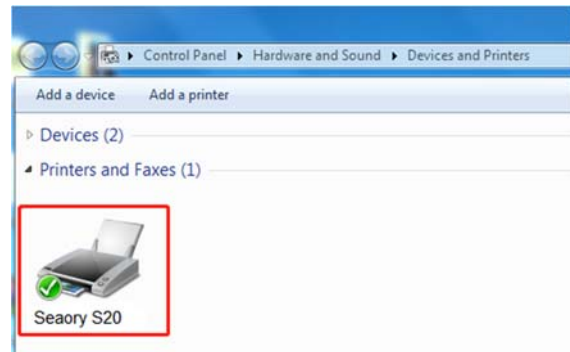

8. Turn on power switch, then the driver will be installed automatically. After installation, please click "Control panel – Hardware and sound – Devices and printers" then you can find Seatory S20 was installed completely.

## 5. Driver setting

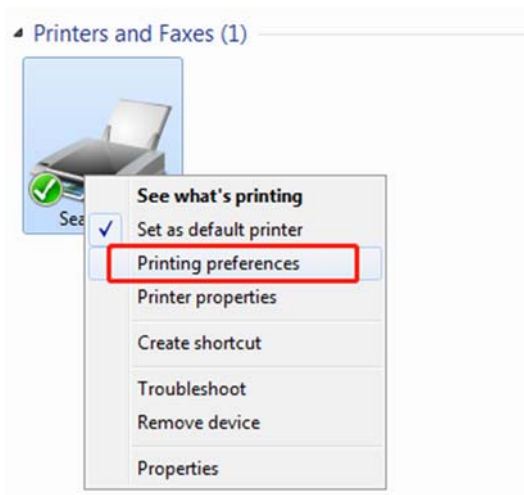

1. In "devices and printers", right click on the printer named "Seatory S20" and select "print preferences".

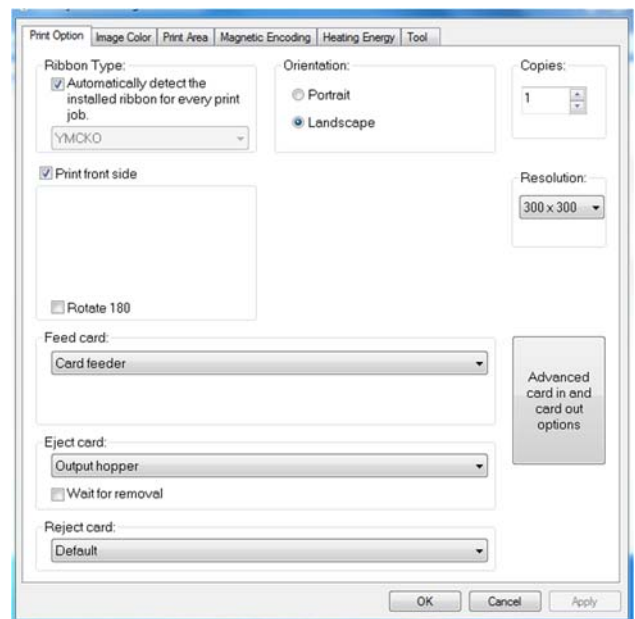

2. Enter the printing preferences setting page.

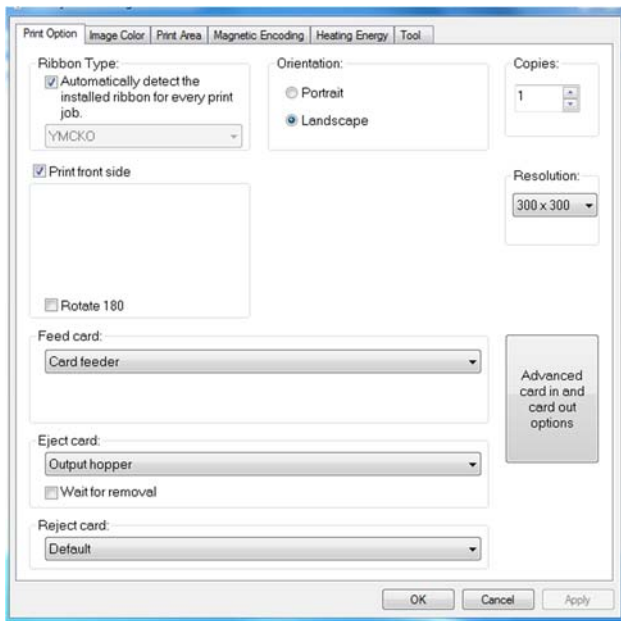

3. This picture shows the printer default Settings. The relevant settings can be adjusted according to different requirements. Please refer to the operation manual for detailed setting.

## 6. Feeding card

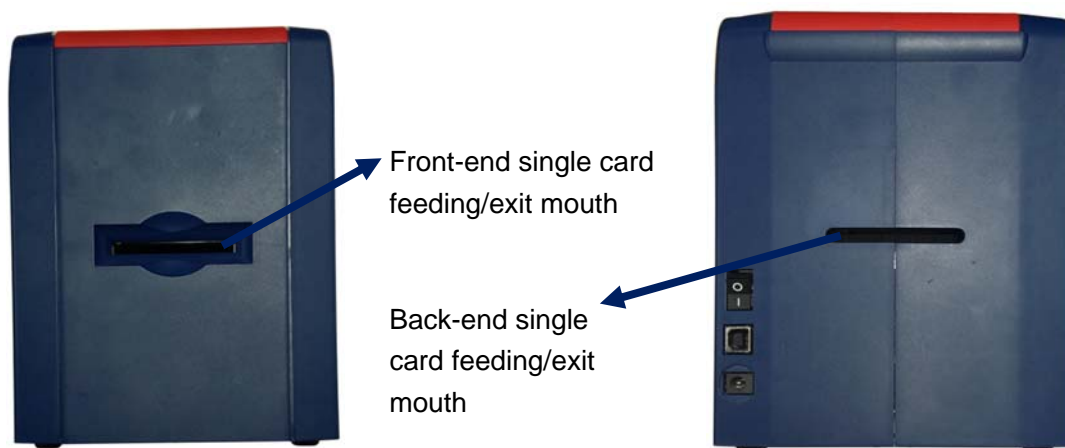

When the card printer is ready, put the card into the front-end or back end card feeding/exit mouth, the card printer will automatically insert the card after detecting the card.

## 7. Print test



After all the above steps are completed, relevant software can be used to print and test the card printer. You can also do print test through Seaory's " iCARDE " software. For details, please refer to Seaory iCARDE manual.